

# S/88 - TENDA A BRACCI CON PIASTRE SEPARATE



BULLONERIE  
INOX ANTIGRIP



*S/88 è una tenda a bracci estensibili con piastre separate. La maneggevole S/88 è moderna, funzionale e adatta anche agli spazi più ristretti. Le sue caratteristiche la rendono particolarmente indicata per le piccole e medie dimensioni.*





*La tenda è applicabile a parete oppure a soffitto ed in spallina, tramite l'impiego di apposite contropiastre.*

*A richiesta, è possibile dotare la tenda di tettuccio di protezione in alluminio.*

*La struttura è azionabile sia ad arganello che a motore.*



## Colori disponibili a magazzino

	Termolaccata Grigio RAL7035		Termolaccata Bianco RAL9010
	Termolaccata Avorio RAL1013		Anodizzata Naturale
	Anodizzata Oro		

Tutte le colorazioni RAL a richiesta

## Ingombri totali

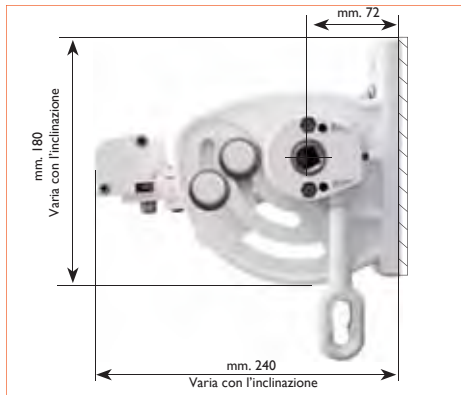

Attacco parete

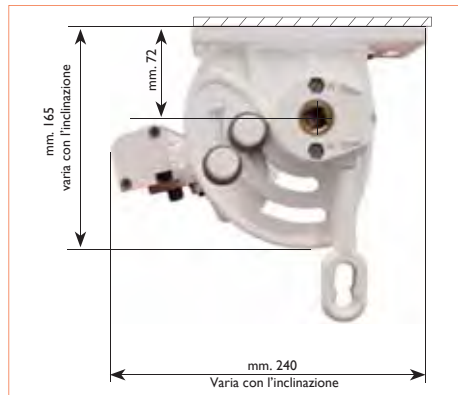

Attacco soffitto

## Tabella ingombro bracci

Sporgenza	mm. 1400	mm. 1600	mm. 1800	mm. 2000	mm. 2200
Larghezza minima richiesta	1580	1780	1980	2180	2380

## Piastra attacco parete/soffitto

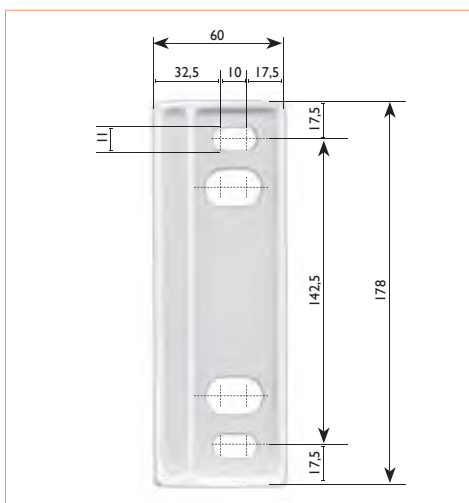

## Inclinazioni

	Inclinazioni $\beta$ minime	Inclinazioni $\beta$ massime
Attacco a parete	0°	90°
Attacco a soffitto	15°	85°

Angolo  $\beta$  calcolato sul centro del braccio

